

MUSEU AEROEESPACIAL DE ANÓPOLIS



ACADÊMICO: MATHEUS DA COSTA ARCOLLO
ORIENTADORA: SIMONE BUIATE

PESQUISA

DOCUMENTAÇÃO

COMUNICAÇÃO

CONSERVAÇÃO

EDUCAÇÃO

PRESERVAÇÃO

AVIAÇÃO

LEONARDO DA VINCI SÉC XV



SANTOS DUMONT 1919



1914 - 1945

AMELIA EARHEART 1928

1946

SMITHSONIAN AIR SPACE MUSEUM

1ª GUERRA MUNDIAL (1914 - 1918)
2ª GUERRA MUNDIAL (1939 - 1945)



SUPERSÔNICO 1950



CORRIDA ESPACIAL (EUAxURSS) 1957

1969 EMBRAER

1970 MIRAGE 3 (FAB)

1972 BAAN

1976 MUSEU AEROESPACIAL RIO DE JANEIRO (MUSAL)

1980 ÔNIBUS ESPACIAL

2006 MUSEU TAM

ANÓPOLIS

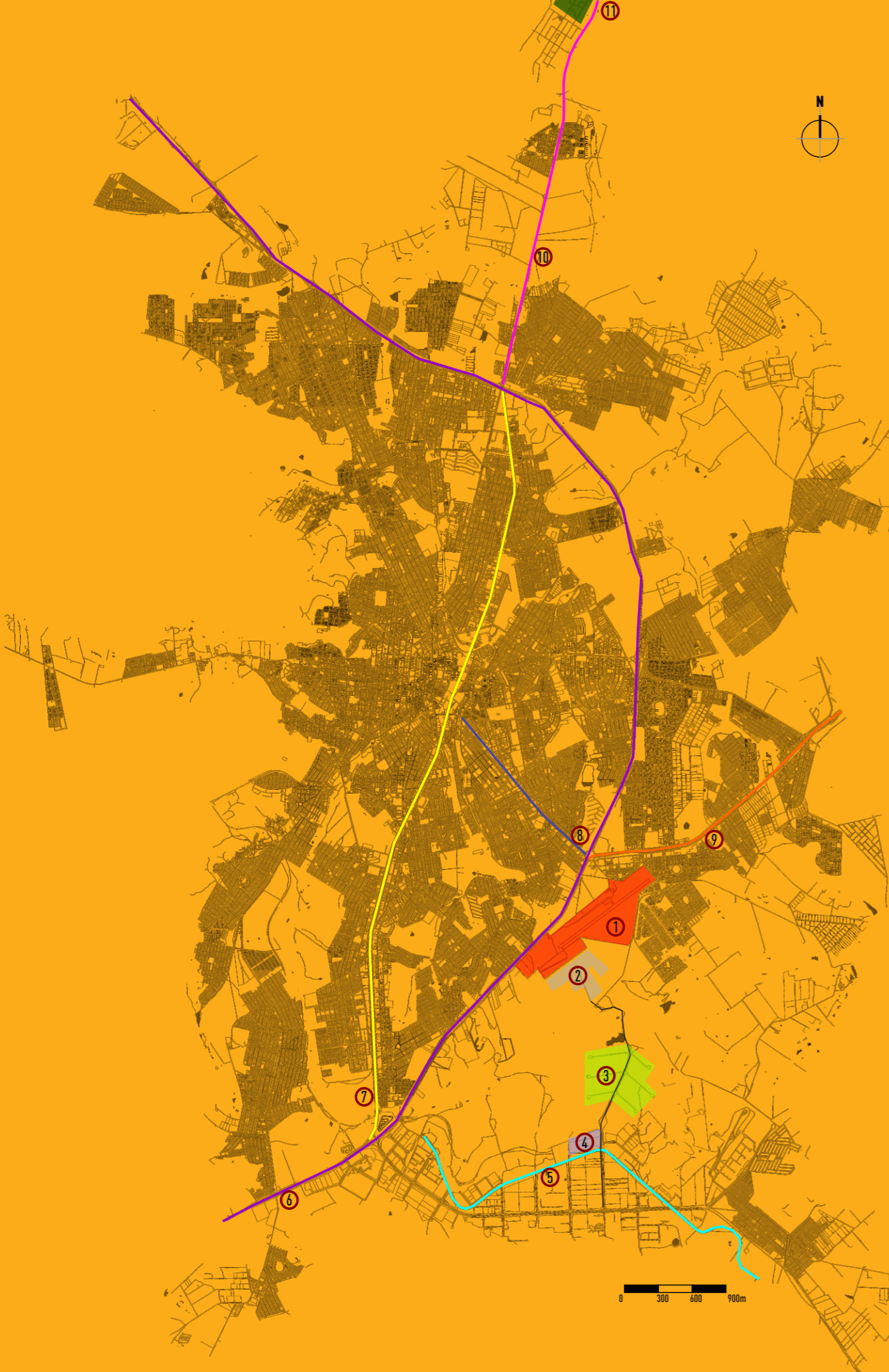

- ① AEROPORTO
- ② EXPANSÃO A
- ③ PLMG
- ④ PORTO SECO
- ⑤ LINHA FÉRREA
- ⑥ BR 153
- ⑦ AV. BRASIL
- ⑧ AV. JK
- ⑨ BR 060
- ⑩ BR 414
- ⑪ BASE AÉREA



Ληόπολις e a Λνιαζõã

BAIAN
1972

BRASÍLIA
MIRAGE III

BAAN





JK – 1956

CONSTRUÇÃO – 1998/2000

REVITALIZAÇÃO – 2016

Ληόπολις e a Aviação

AEROPORTO DE CARCAS
1950-60

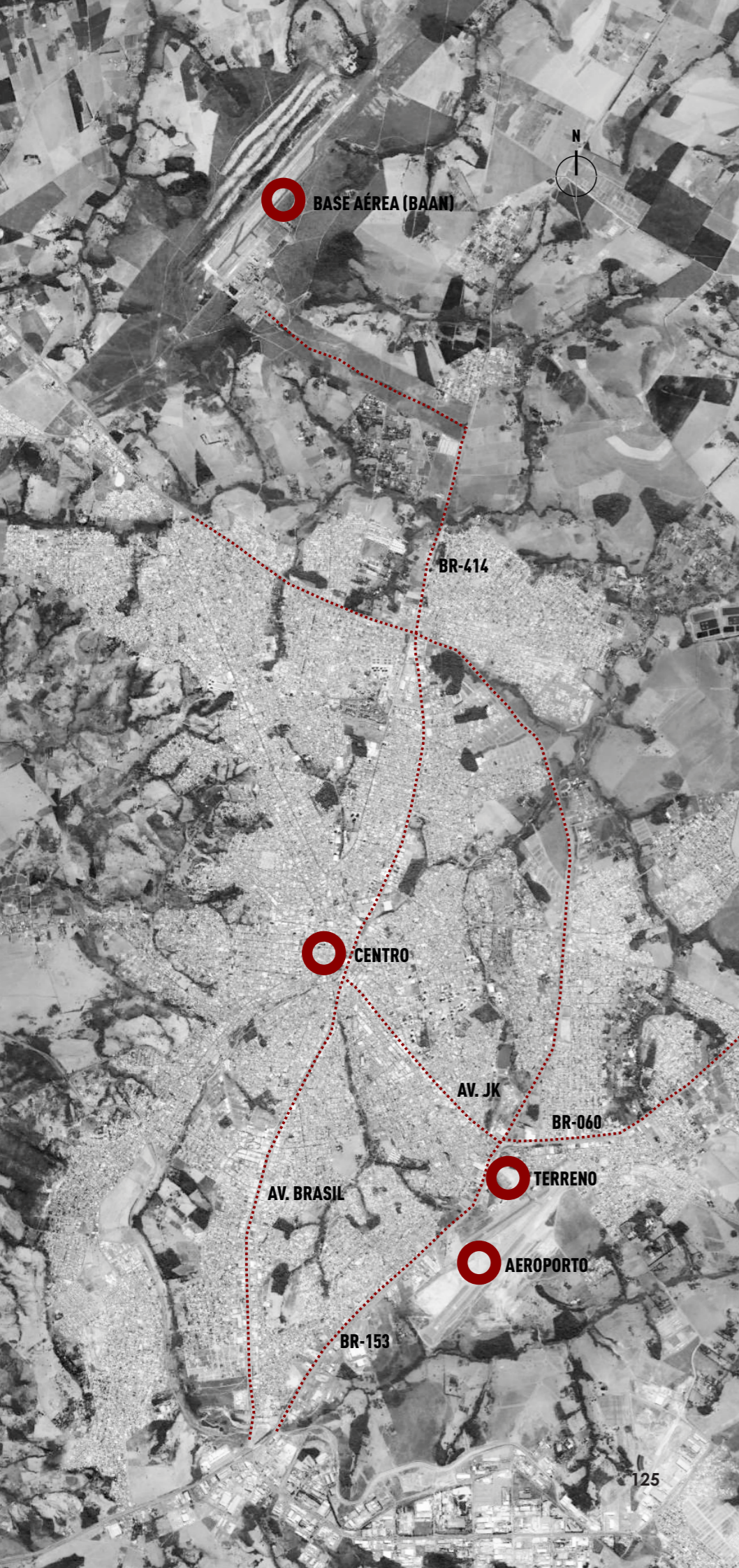

 LUCOR

BAAN
AEROPORTO

ESCALA DE PROJETO

ACCESOS



① JUNDIAÍ

② JK

⑥ AV. JK

⑪ BR 060

③ JARDIM ALVORADA

⑦ TERRENO

⑤ VILA OPERÁRIA

④ CAMPOS ELÍSIOS

⑧ AV. BRASIL

⑩ AEROPORTO

⑨ BR 153



○ LUCAR

101.316 M2

TOPOGRAFIA

○ PROGRAMA

NÚCLEOS

O PROGRAMA

CIRCULAÇÃO

espaço
conteúdo

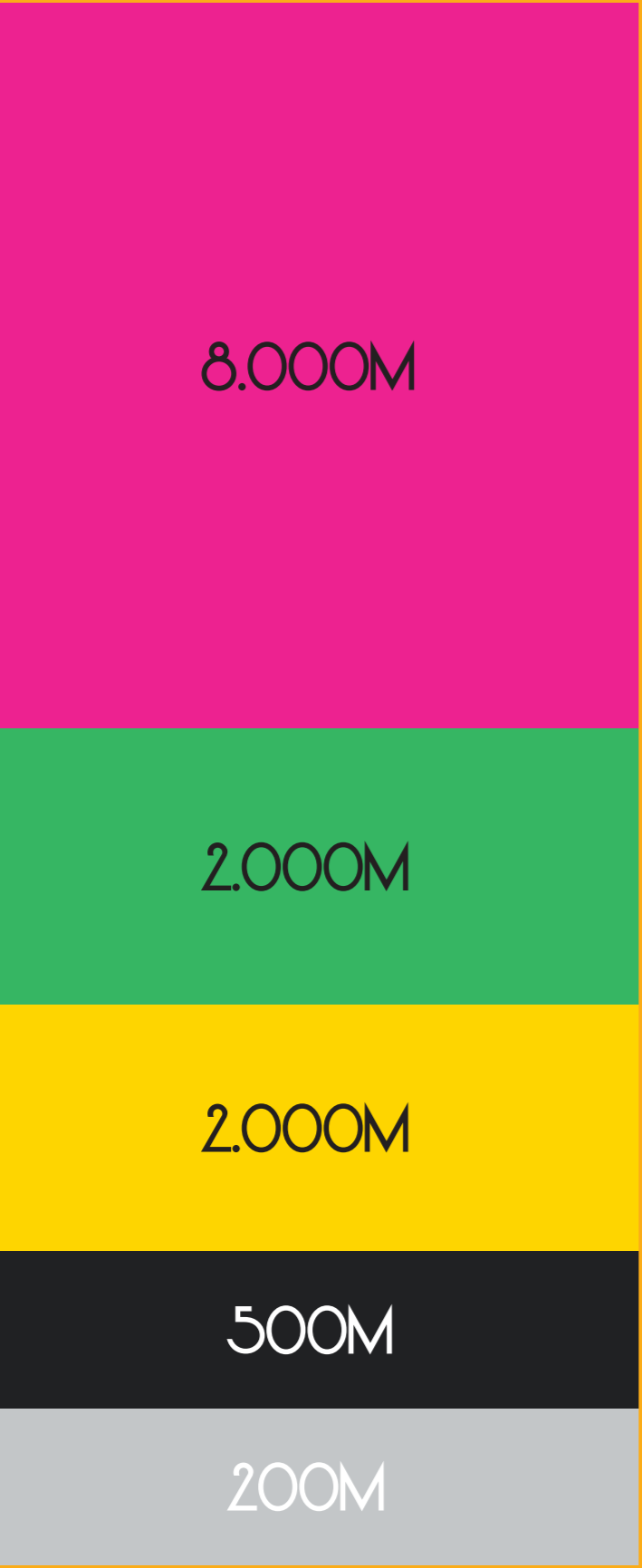

EXPOSIÇÕES

TRATAMENTO

INTERATIVO

SOCIAL

ADM



EXPOSIÇÃO PERMANENTE

EXPOSIÇÃO TEMPORÁRIA

EXPOSIÇÃO LONGA DURAÇÃO

DOCAS

TRIAGEM

OFICINA

LABORATÓRIO

INTERATIVO

BILHETERIA

HALL

SANITÁRIOS

SOUVENIERS

LANCHONETE

ADMINISTRAÇÃO

SALA DOS FUNCIONÁRIOS

COPA/COZINHA

RH

ALMOXARIFADO

DEPÓSITO

SANITÁRIOS

O PROGRAMA

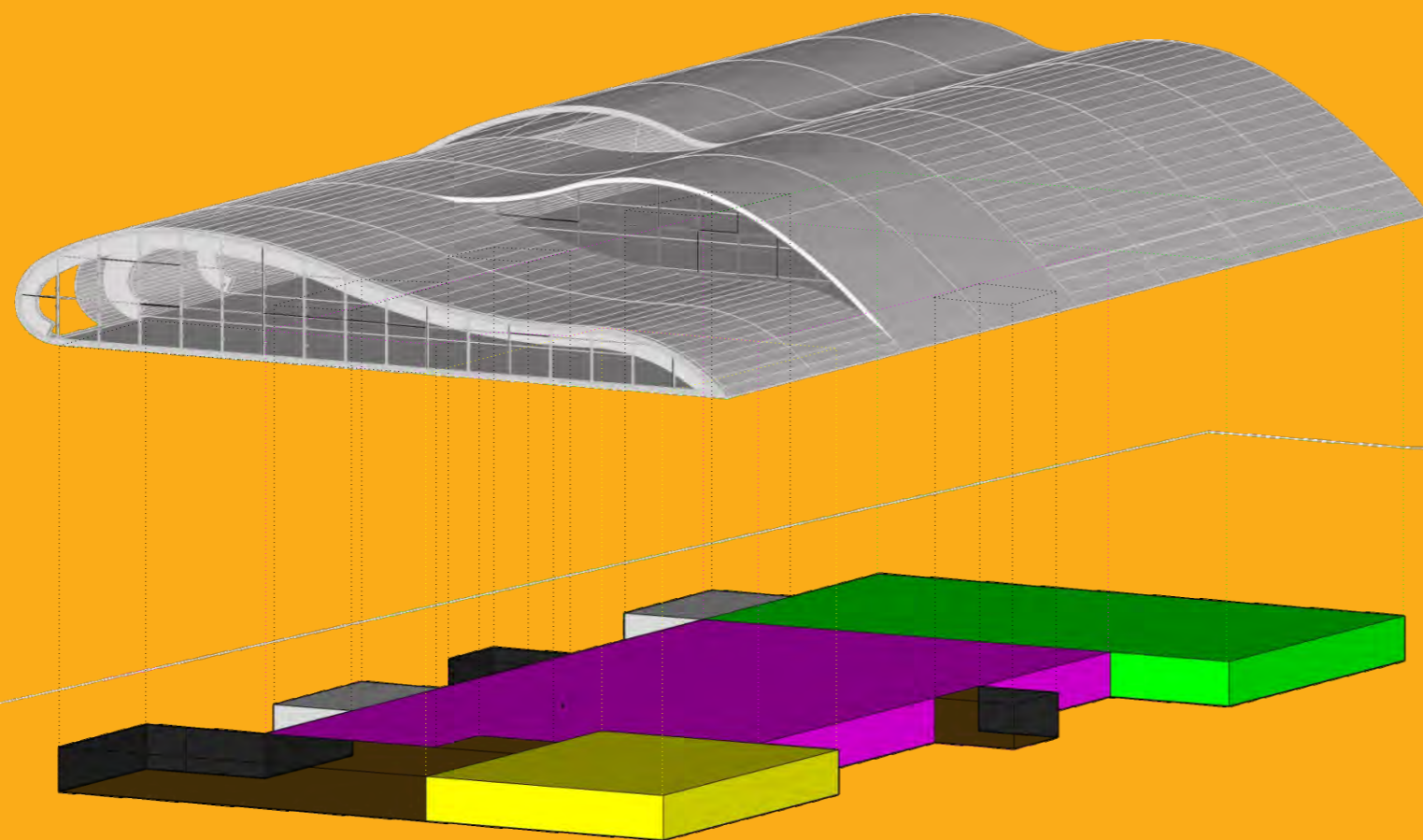

- SOCIAL
- INTERATIVO
- EXPOSICÇÕES
- TRATAMENTO
- ADMINISTRAÇÃO
- CIRCULAÇÃO

EXPERIÊNCIAS
INDIVIDUAIS

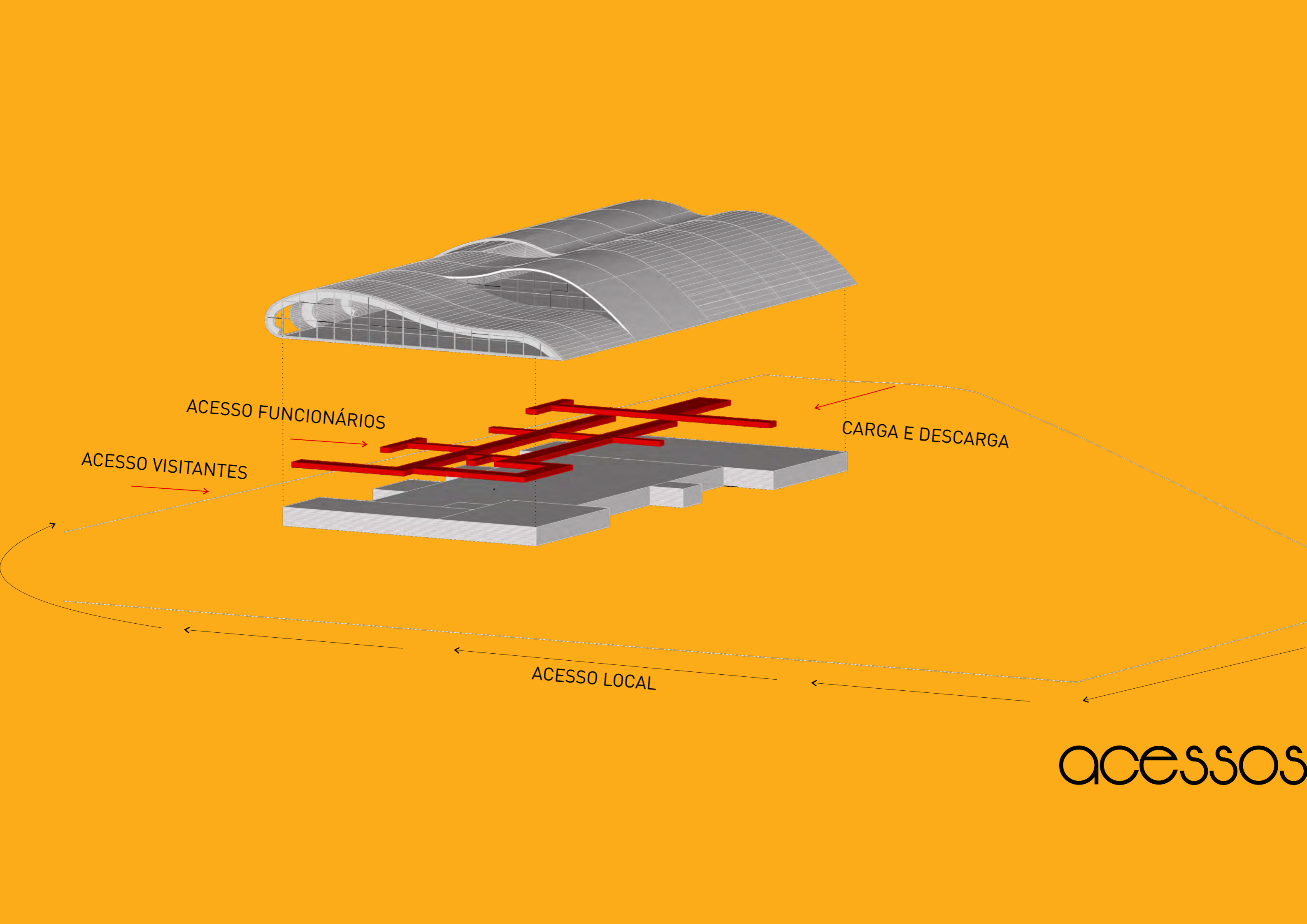

ACESSO FUNCIONÁRIOS

ACESSO VISITANTES

CARGA E DESCARGA

ACESSO LOCAL

acessos

○ PROJETO



CONCEPÇÃO PROJETUAL

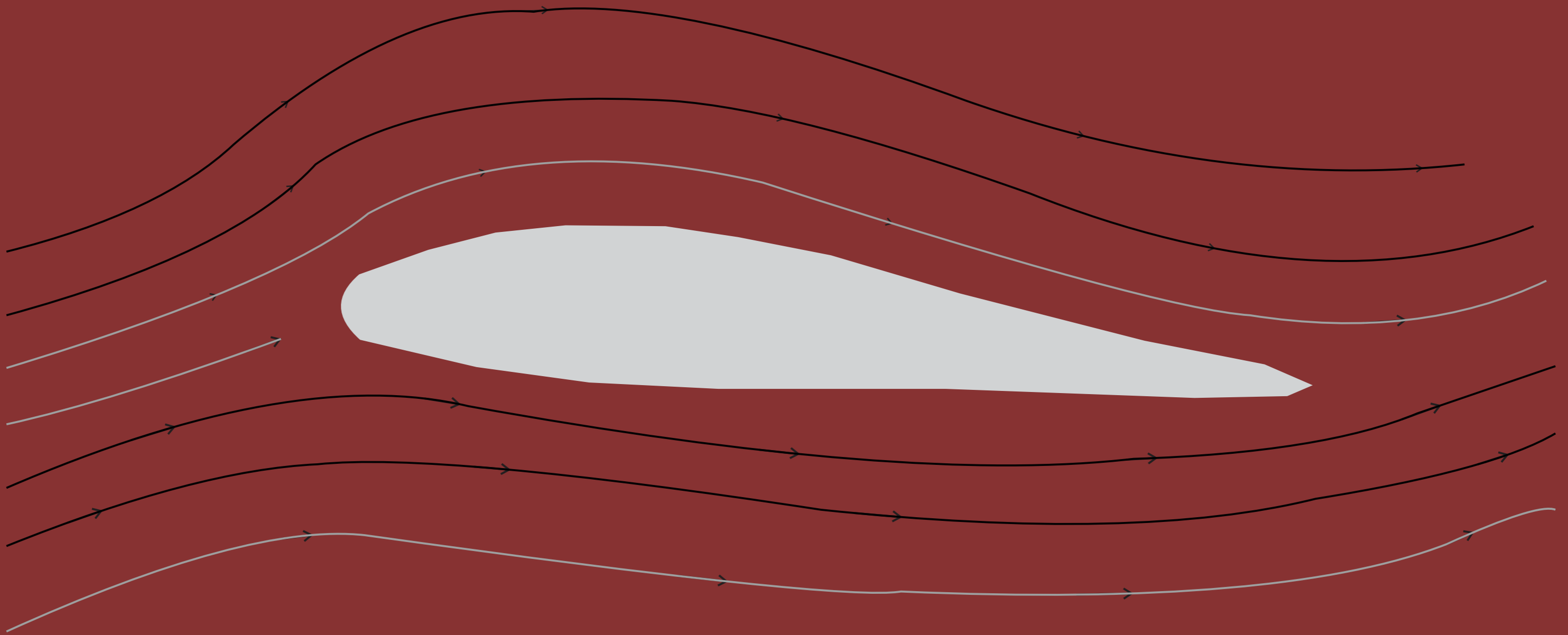

CONCEPÇÃO
PROJETUAL

MOVIMENTO

ESTRUTURA
PERCEPÇÃO

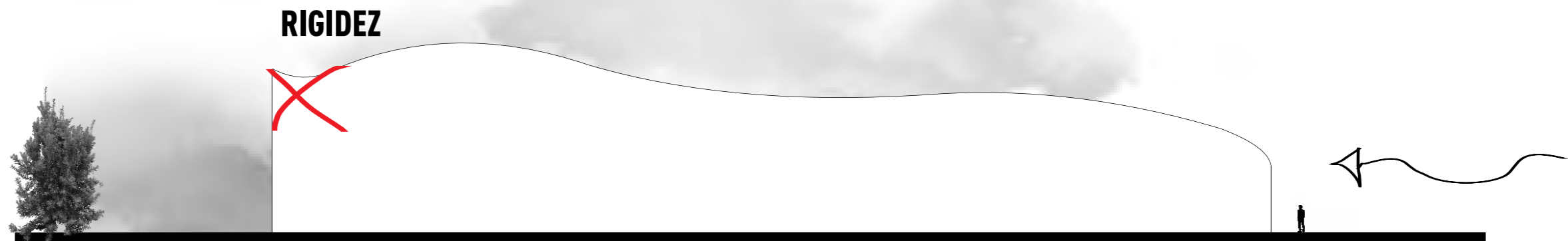

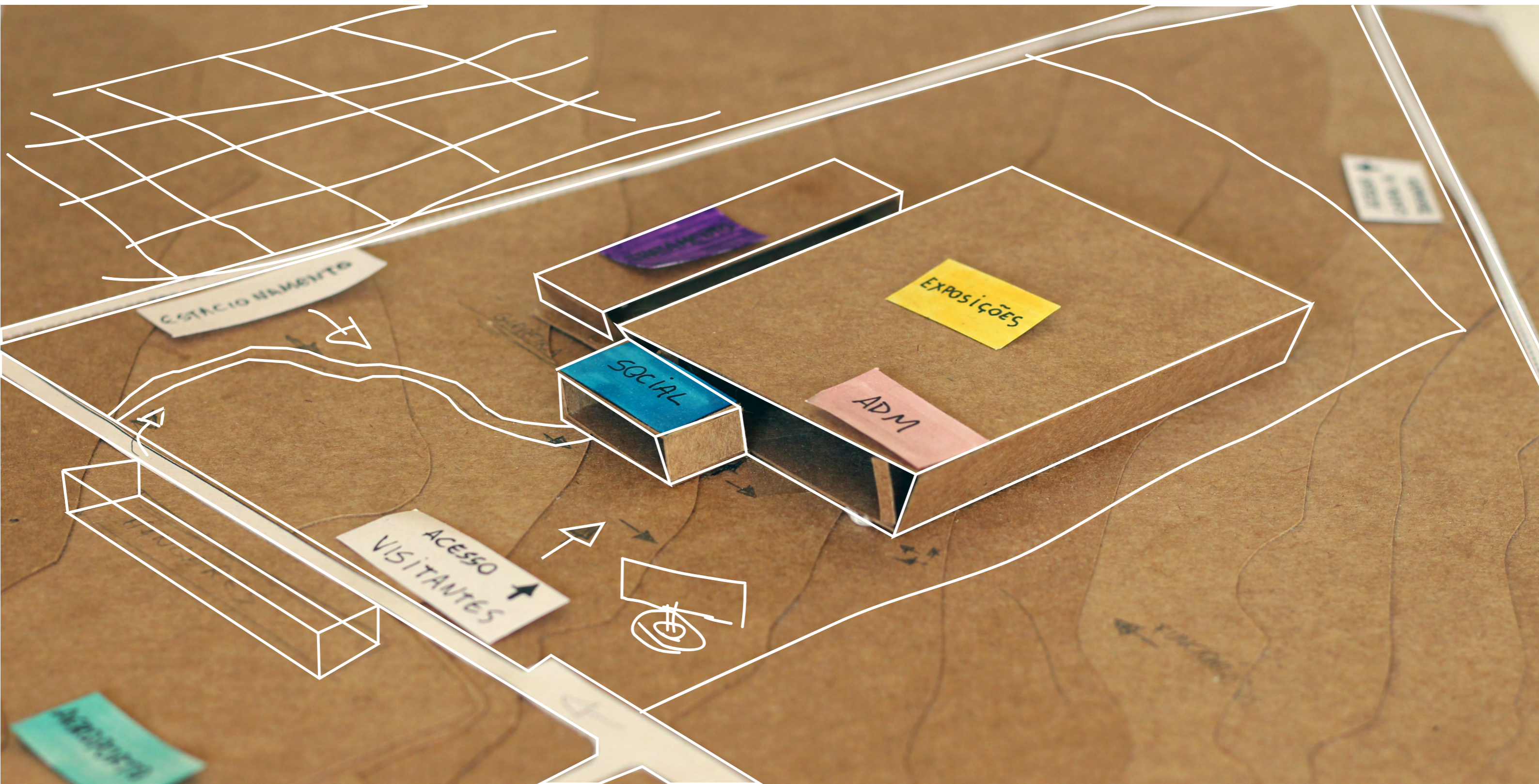

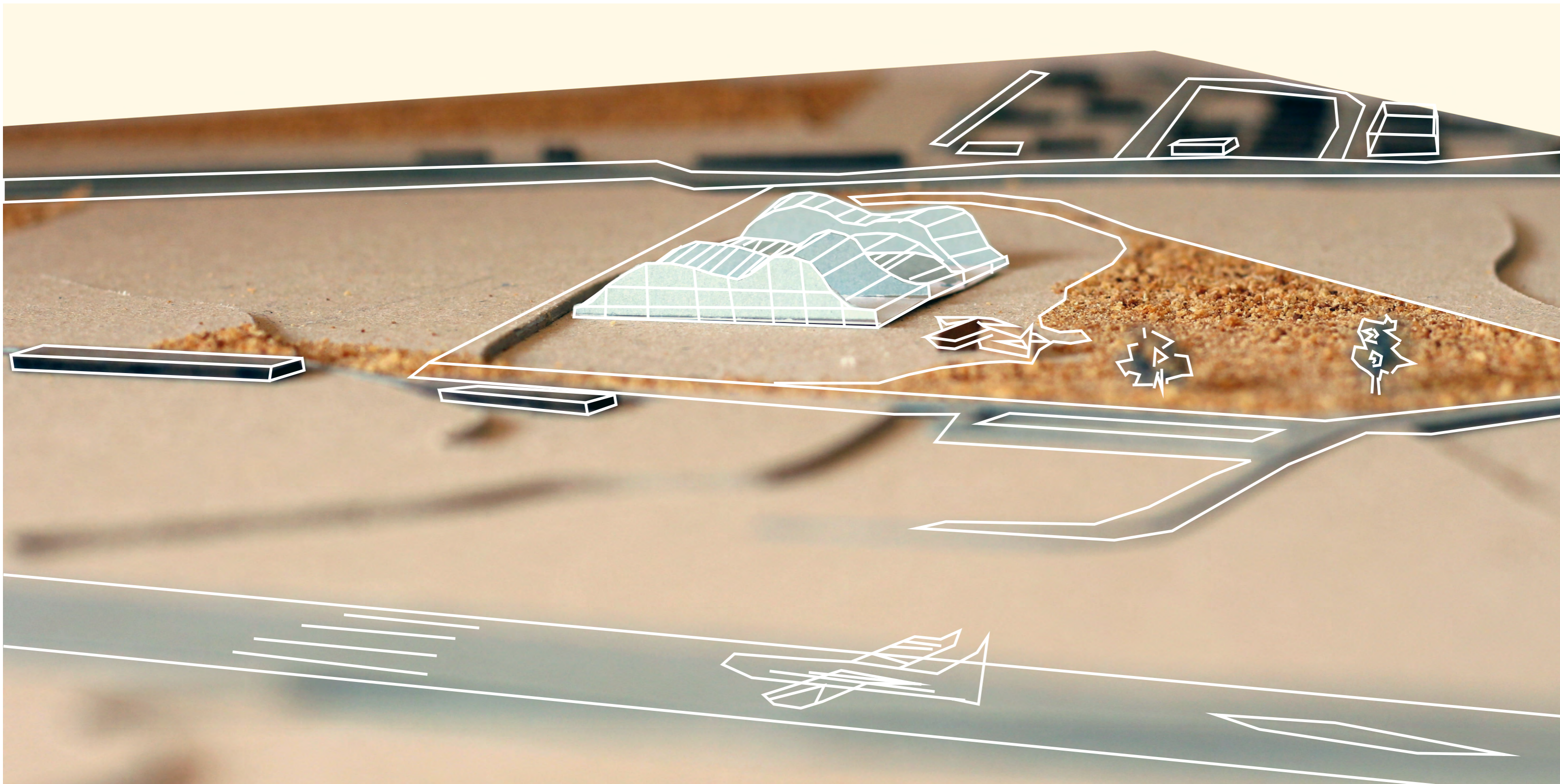

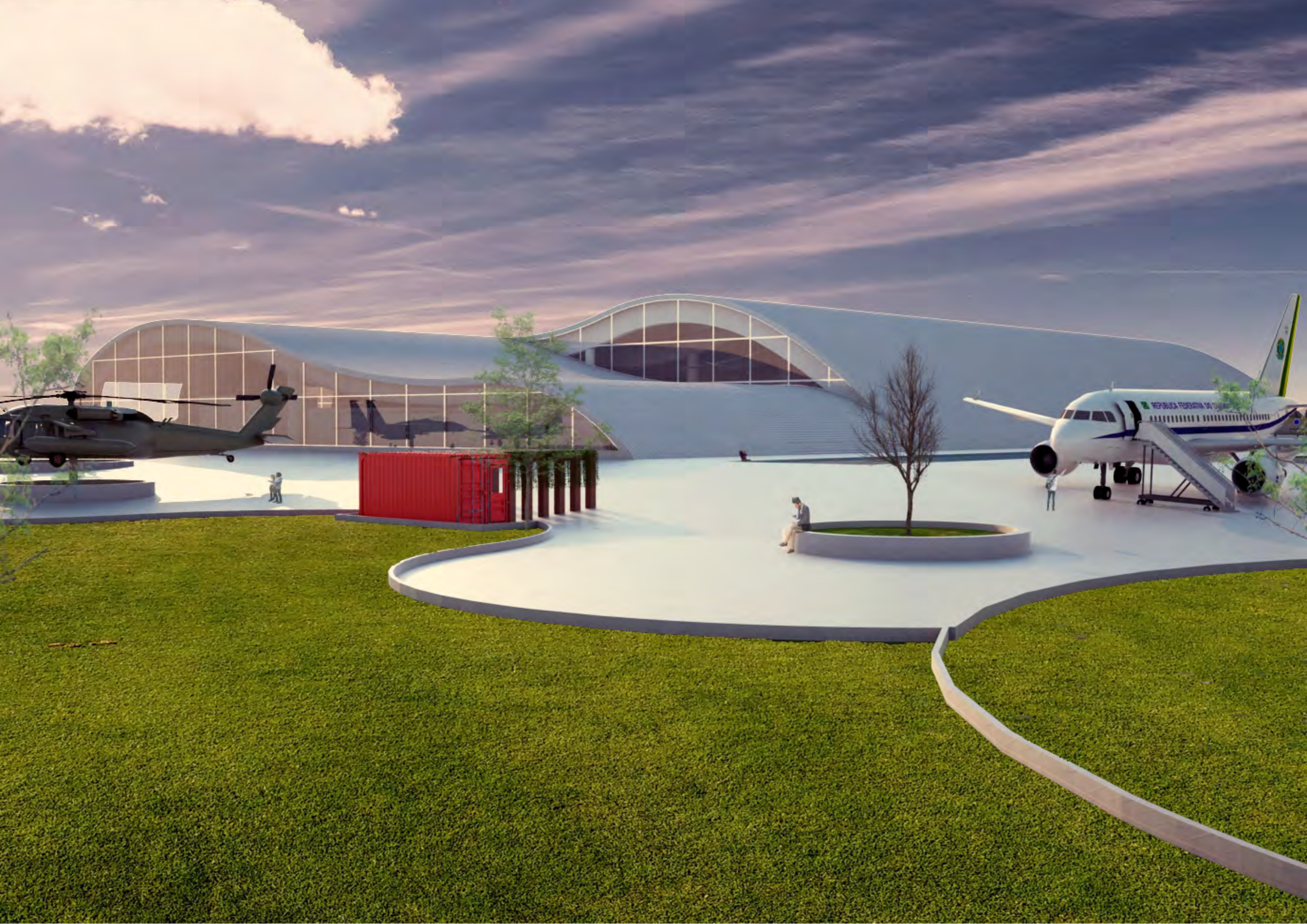

- | | |
|-------------------------------|--------------------|
| ① ESTACIONAMENTO VISITANTES | ⑭ COPA/COZINHA |
| ② ESTACIONAMENTO FUNCIONÁRIOS | ⑮ RH |
| ③ ACESSO VISITANTES | ⑯ ALMOXARIFADO |
| ④ ACESSO FUNCIONÁRIOS | ⑰ DEPÓSITO |
| ⑤ HALL | ⑱ SANITÁRIOS |
| ⑥ SANITÁRIOS | ⑲ SEGURANÇA |
| ⑦ BILHETERIA | ⑳ OFICINA |
| ⑧ INFORMAÇÕES | ㉑ TRIAGEM |
| ⑨ MUSEU INTERATIVO | ㉒ LABORATÓRIO |
| ⑩ SOUVENIERS | ㉓ ADM TRATAMENTO |
| ⑪ AUDITÓRIO | ㉔ SANITÁRIOS |
| ⑫ ADMINISTRAÇÃO | ㉕ SALA DE DESCANSO |
| ⑬ SALA DOS FUNCIONÁRIOS | ㉖ LANCHONETE |



0 15 30 45m

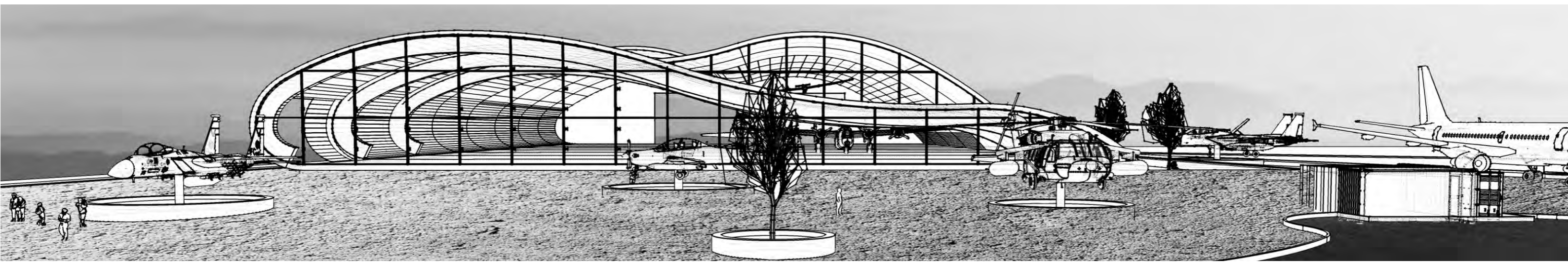
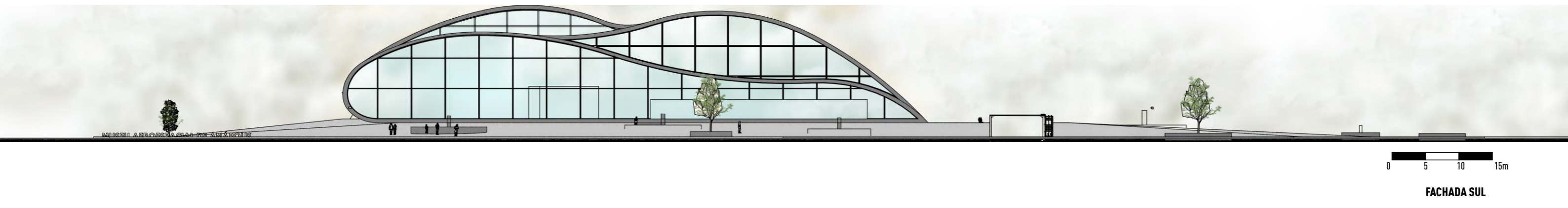
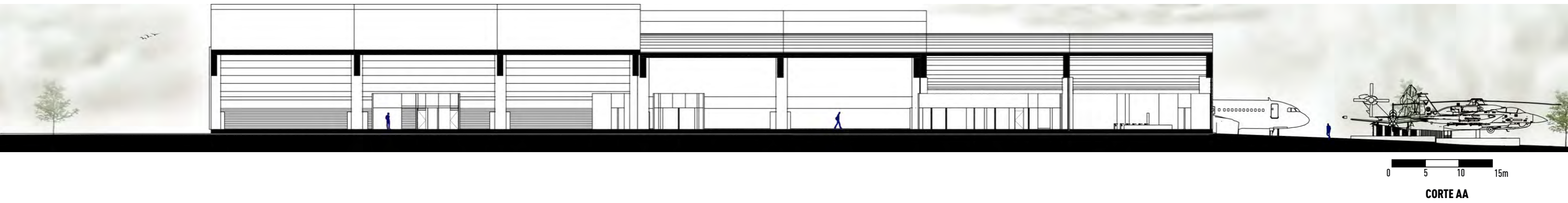

DETALHES

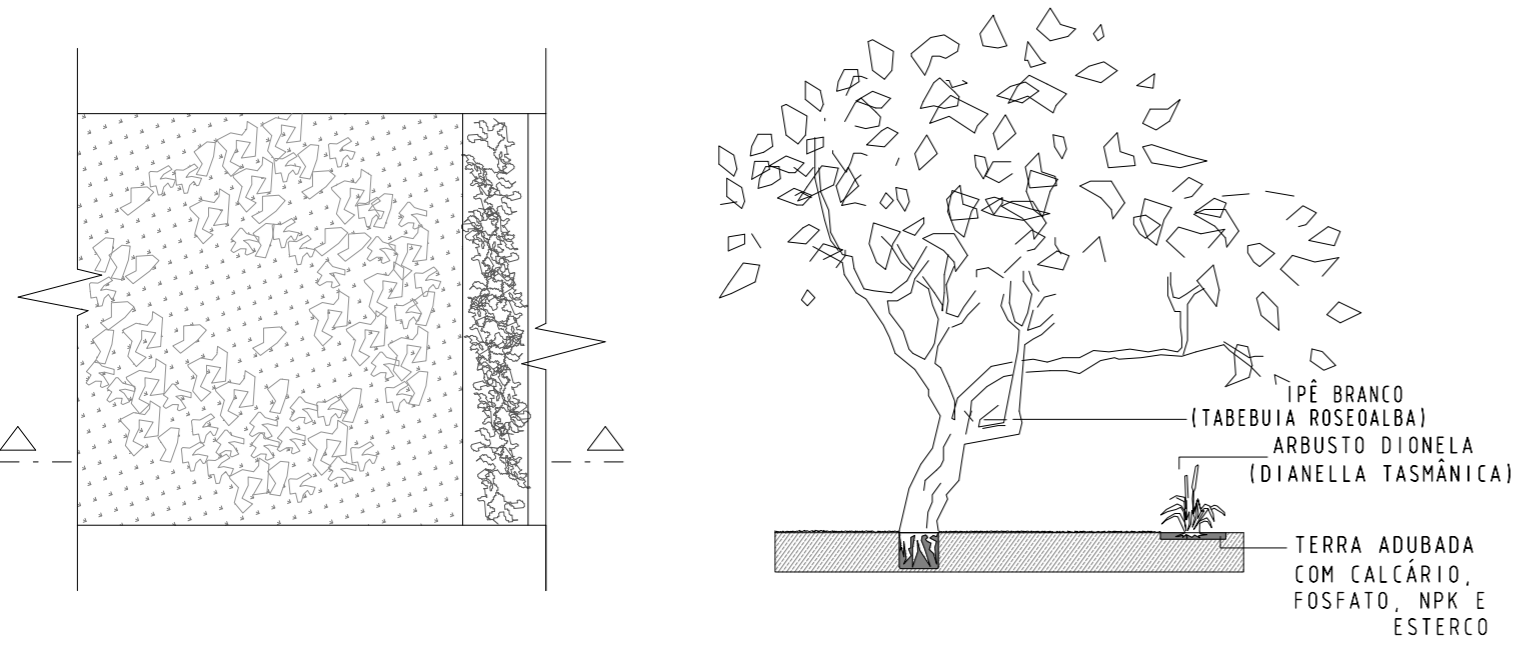

DETALHE 1

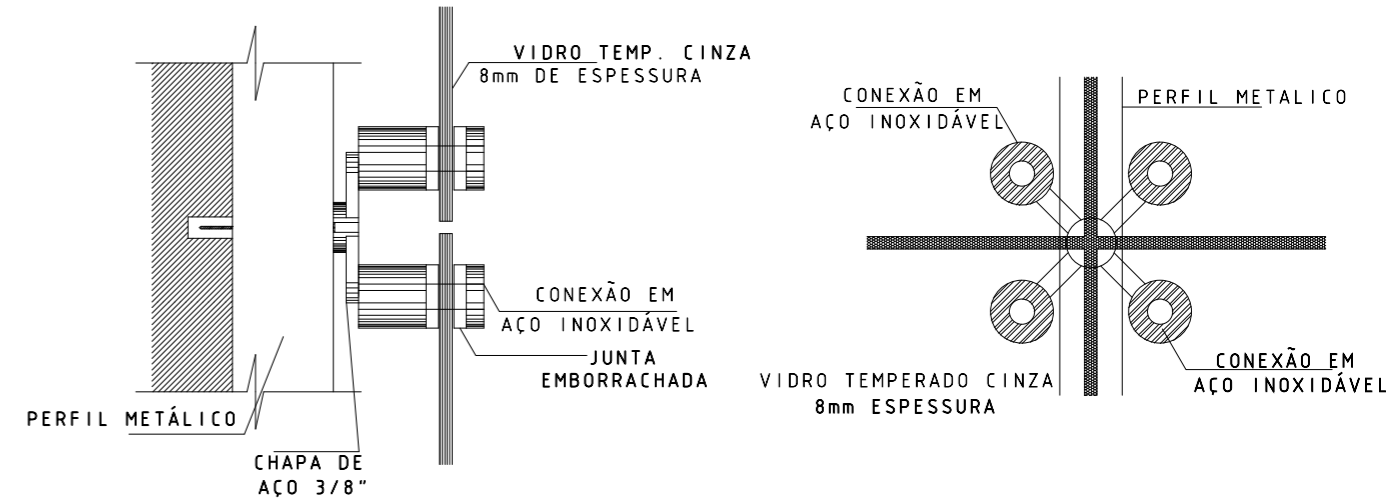

DETALHE 3

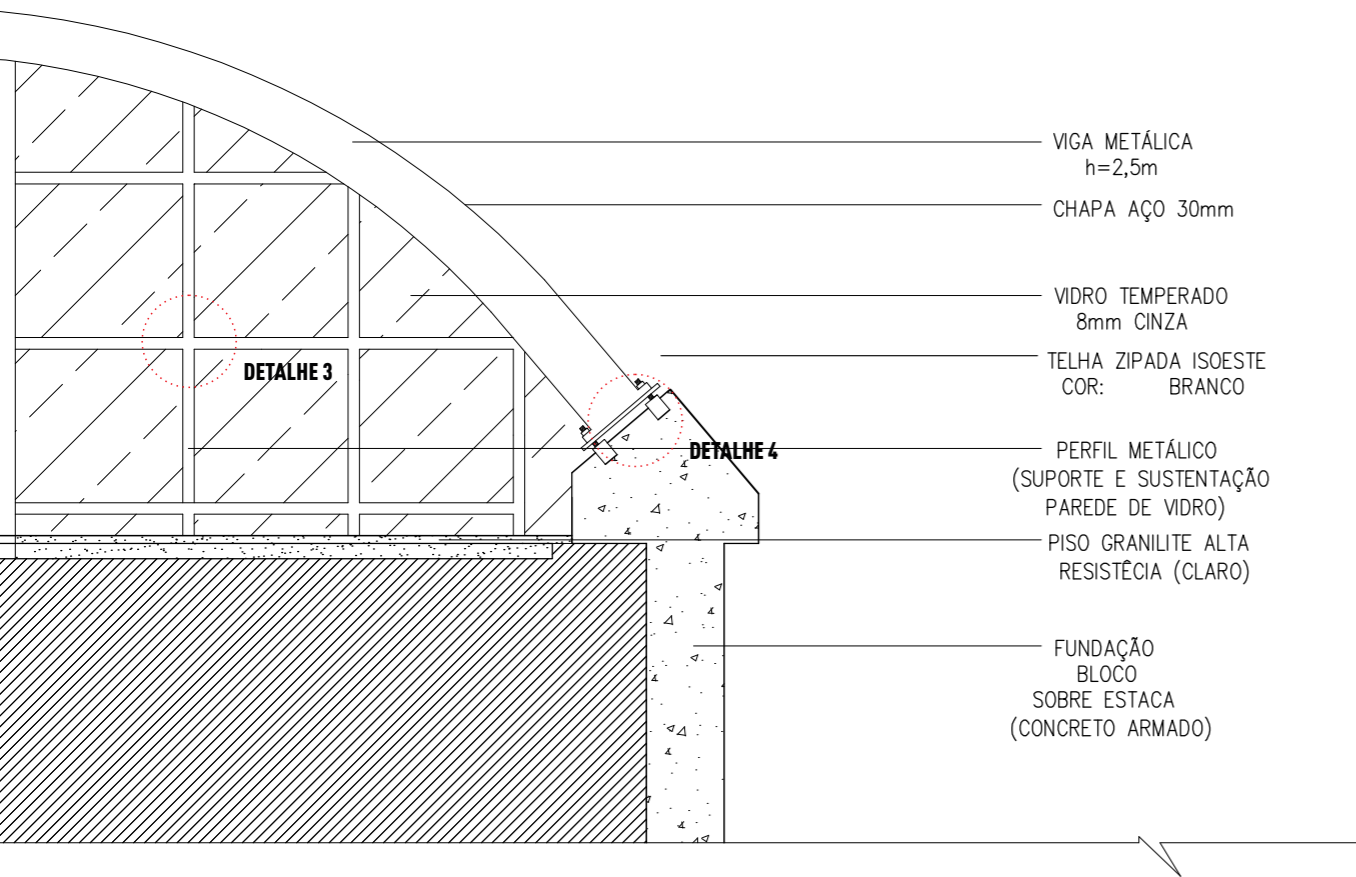

DETALHE 2

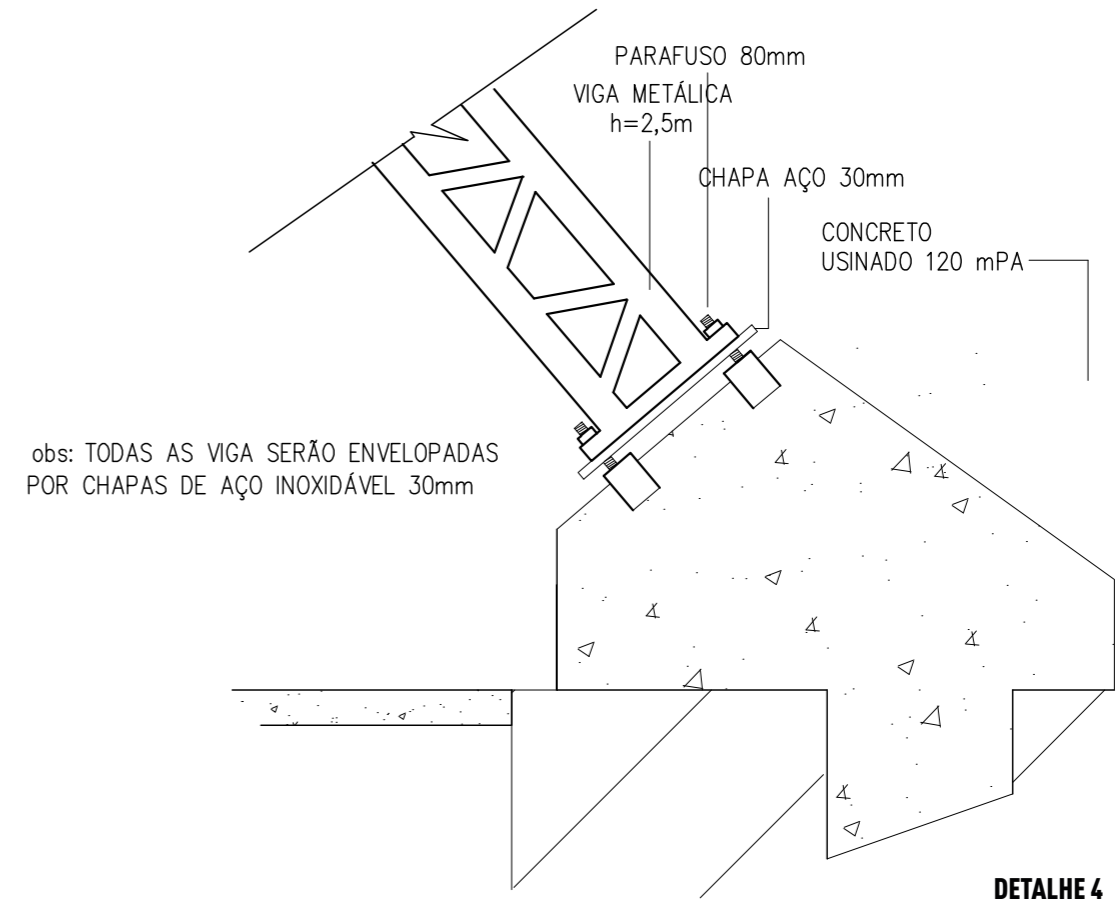

DETALHE 4

ESTRUTURA

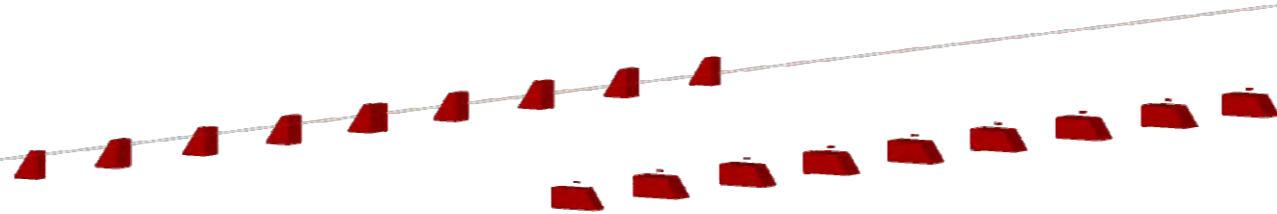
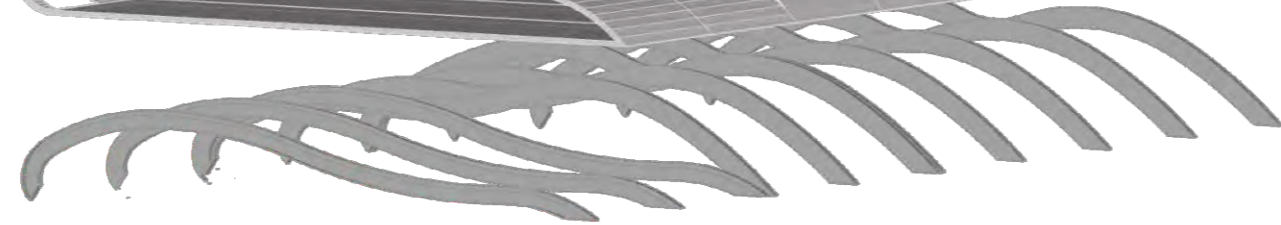
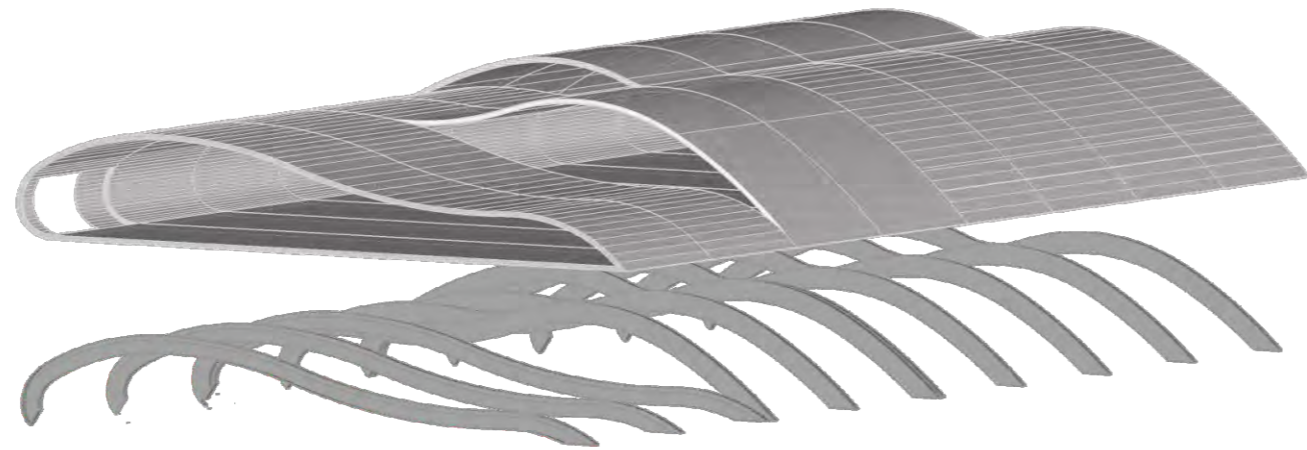

ESTRUTURA

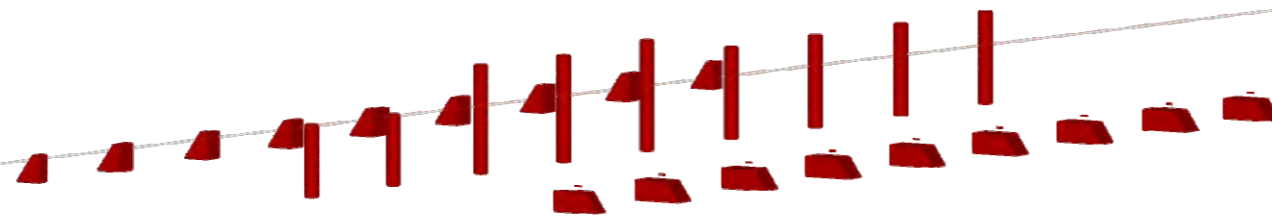
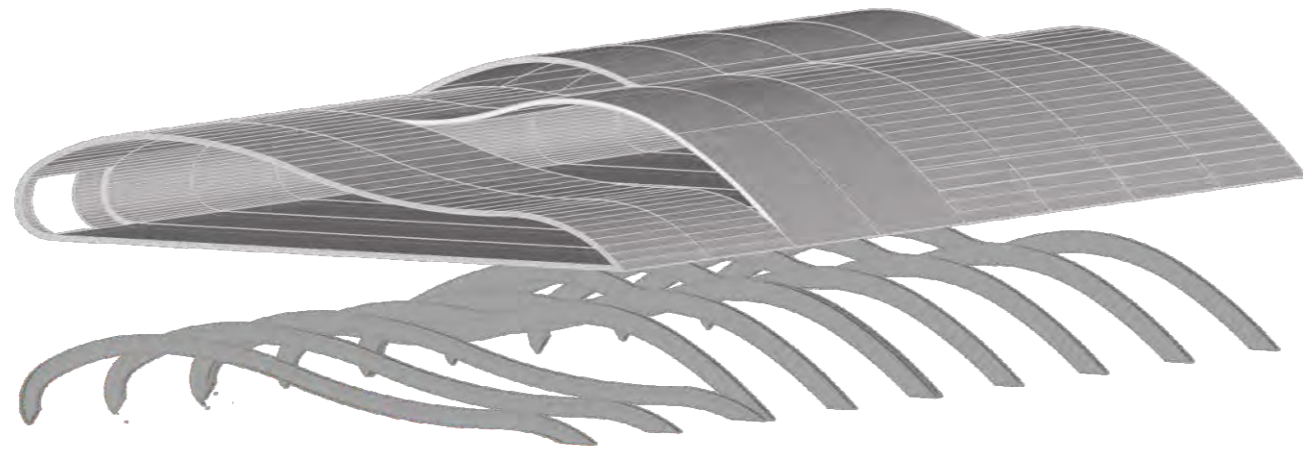

ESTRUTURA

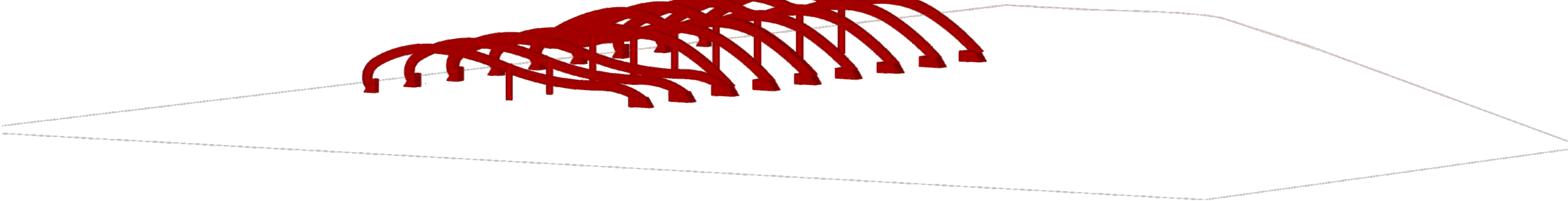
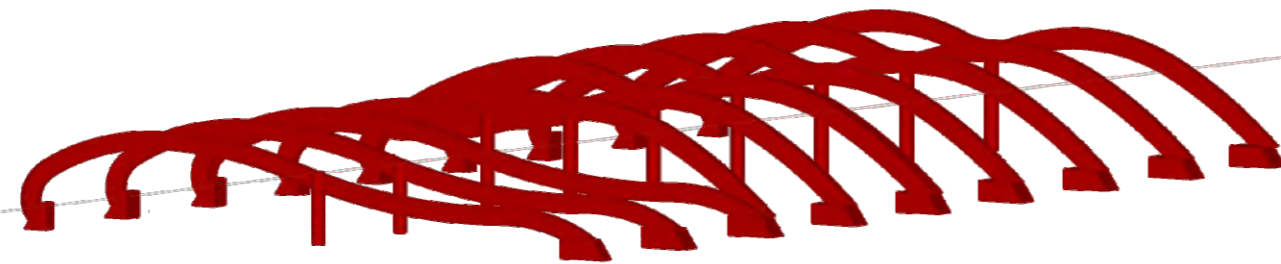
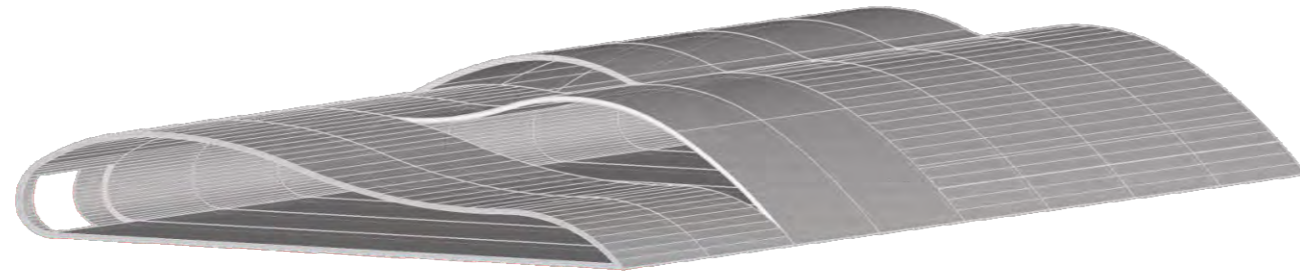

ESTRUTURA

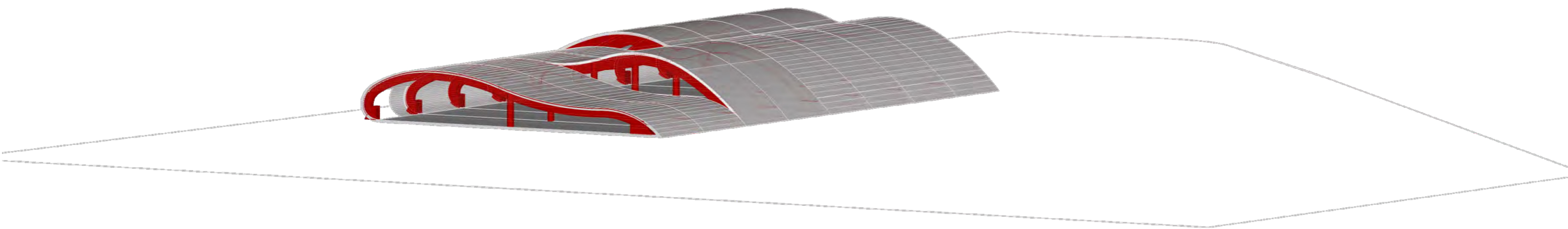

PAISAJISMO

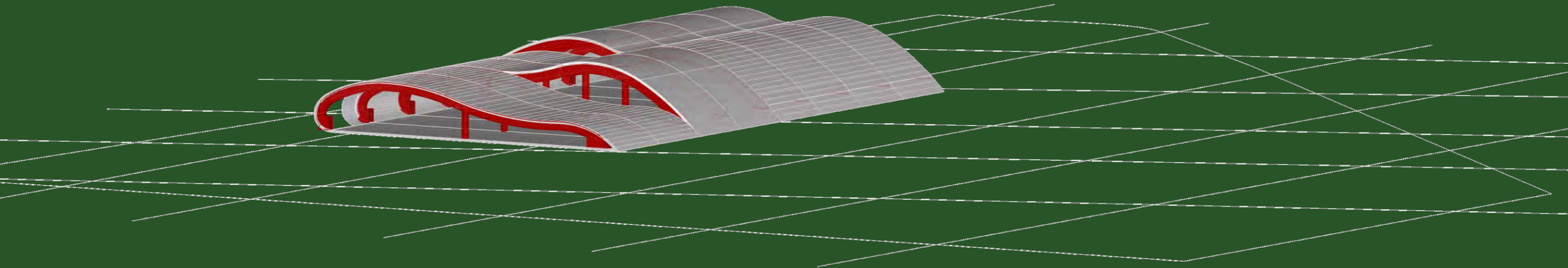

PAISAJISMO

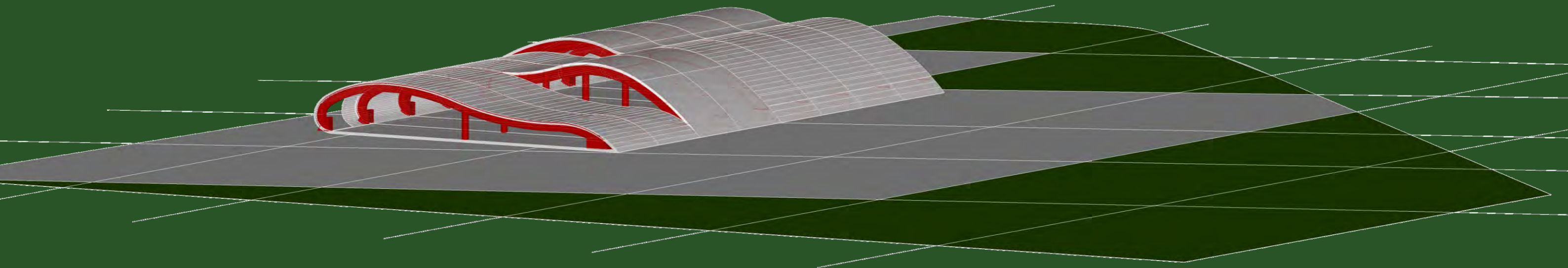

PAISAJISMO

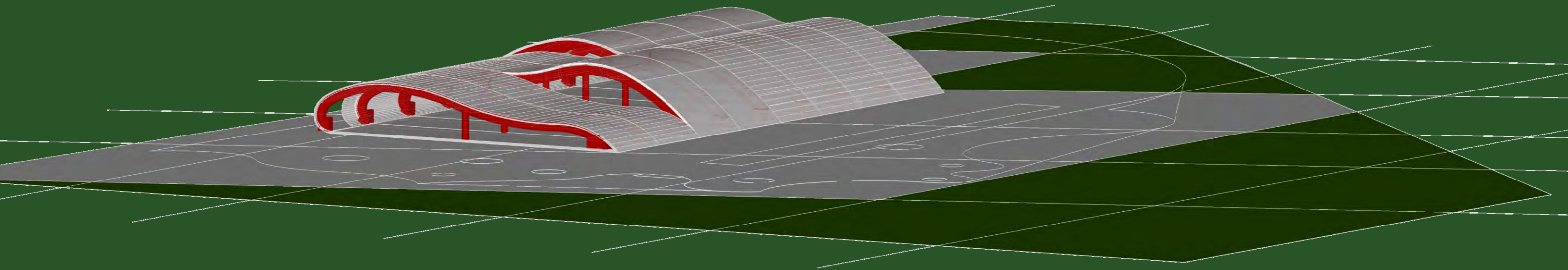

PAISAJISMO

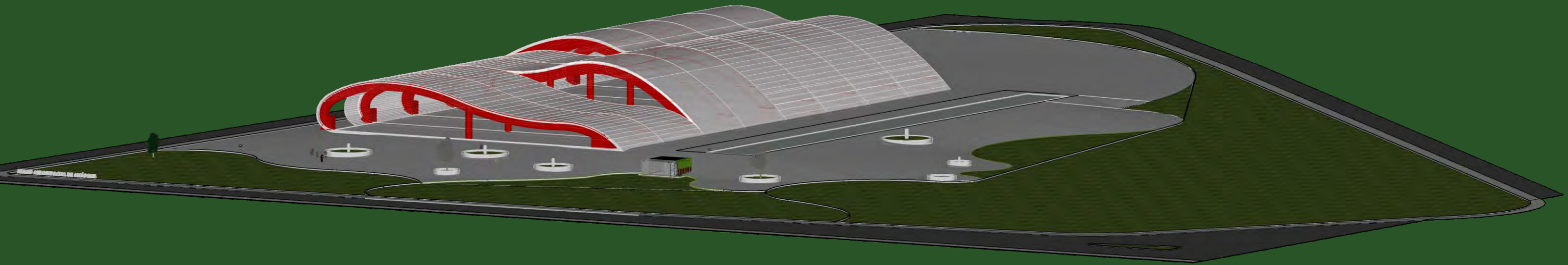

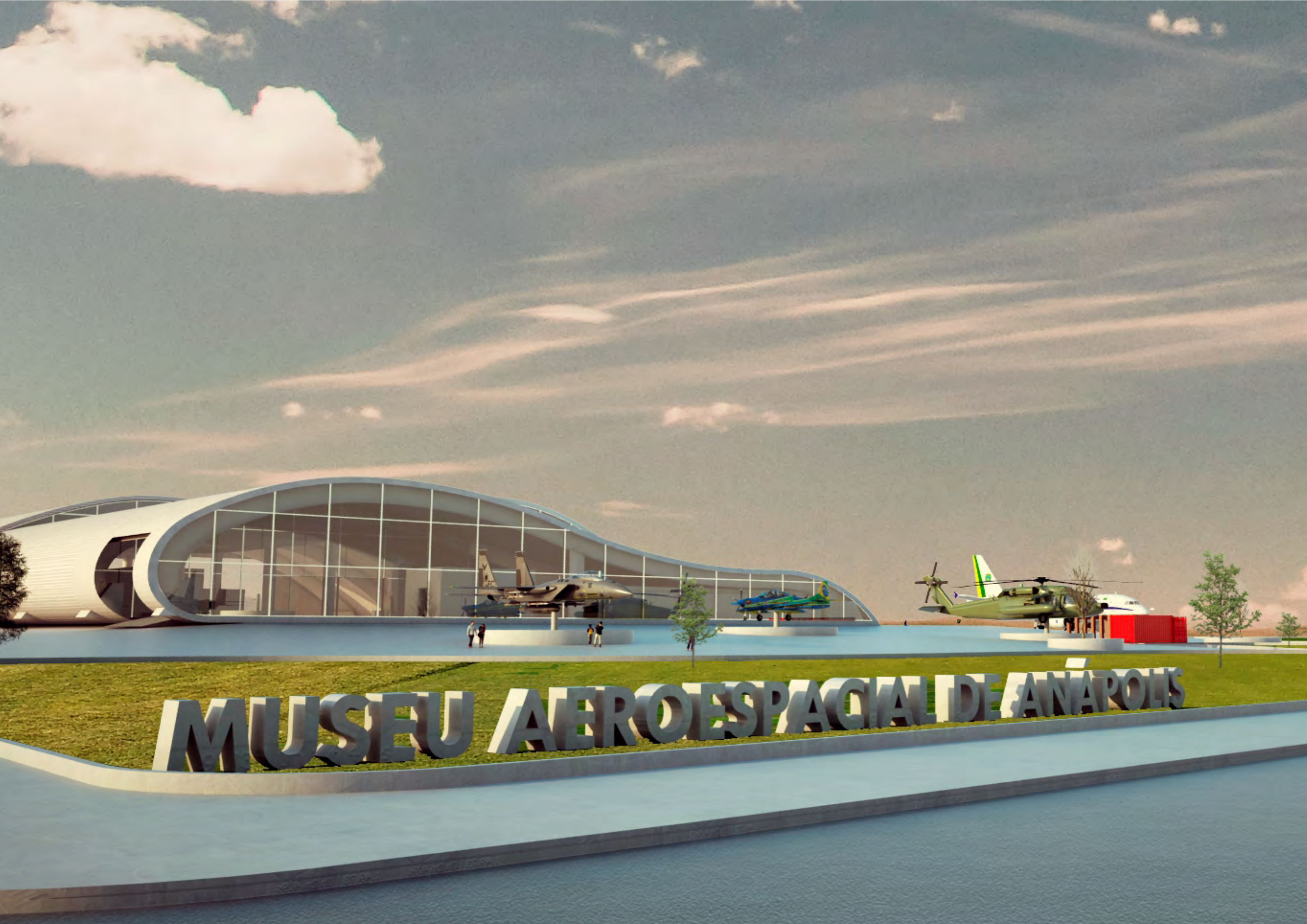

MUSEU AEROSPACIAL DE ANÁPOLIS